



DWG NO	RM_05T2P-P^A@\$\$#D	REV	-
MODEL CODE	RM_05T2P-P^A@\$\$#D		
TITLE	2 Speed D05 Sandwich Module M/I P Pilot Operated Poppet PC Flow Control		
DATA UNIT: INCH	3RD ANGLE PROJECTION		

MODEL CODE BREAKDOWN

RM_05T2P-P^A@\$\$#D

- Material Code () A Aluminum Body
D Ductile Iron Body
- Adjustment Code (^) L Standard Screw
- Seal Material Code (@) N Buna
V Viton
- Rest Condition Code (\$) C Normally Closed (Slow)
H Normally Open (Fast)
- Voltage Code (##) 11 110 Vac
24 24 Vdc

PROPRIETARY NOTICE
THIS DRAWING DESCRIBES A PROPRIETARY PRODUCT OF LYNCH FLUID CONTROLS INC. WHICH MAY NOT BE REPRODUCED IN WHOLE OR IN PART NOR GIVEN TO A THIRD PARTY WITHOUT WRITTEN PERMISSION FROM LYNCH FLUID CONTROLS INC.

ITEM	QTY	DESCRIPTION
1	1	Manifold Body
2	5	Seal Kit
3	1	[Flow Control] Fully adjustable pressure compensated flow control valve with reverse flow check
4	1	[Main Stage] 2-way, poppet directional valve with integral T-8A control cavity - control 1-2
5	1	[Solenoid] 2-way, solenoid-operated directional spool valve - pilot capacity
6	1	Coil
7	1	Connector
8	1	Nameplate
9	4	Screws

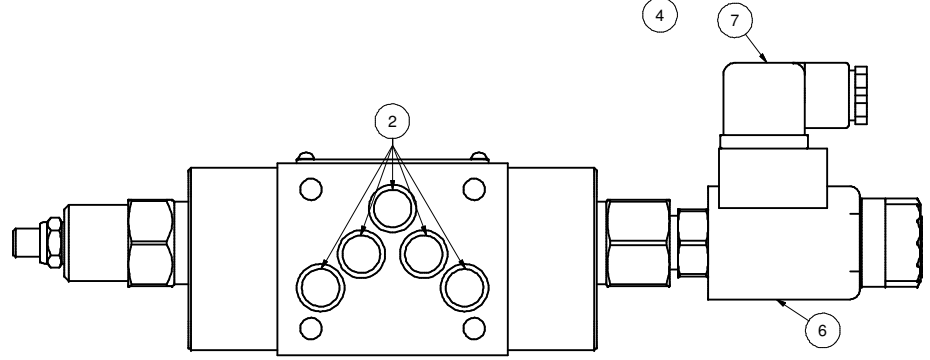
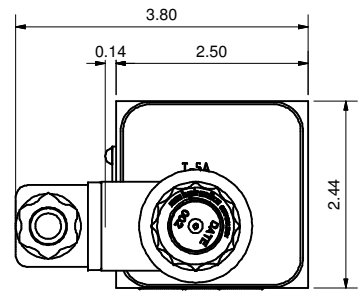
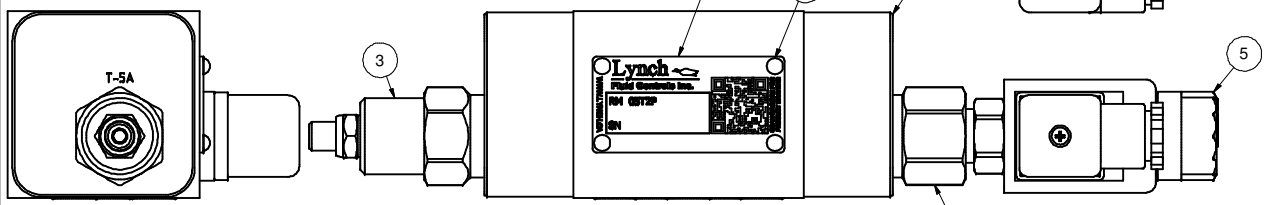
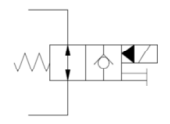
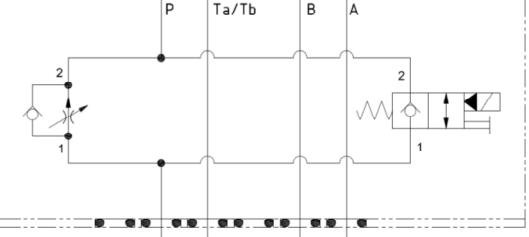
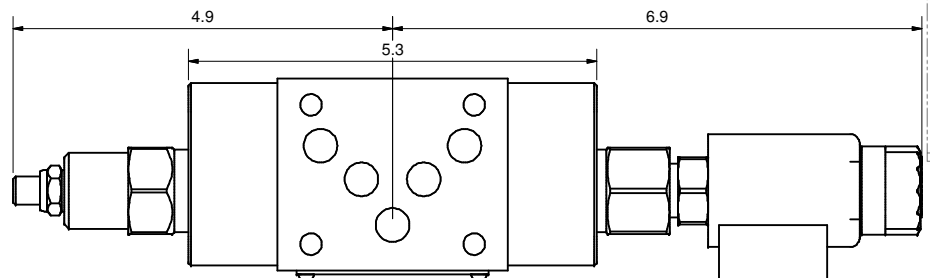
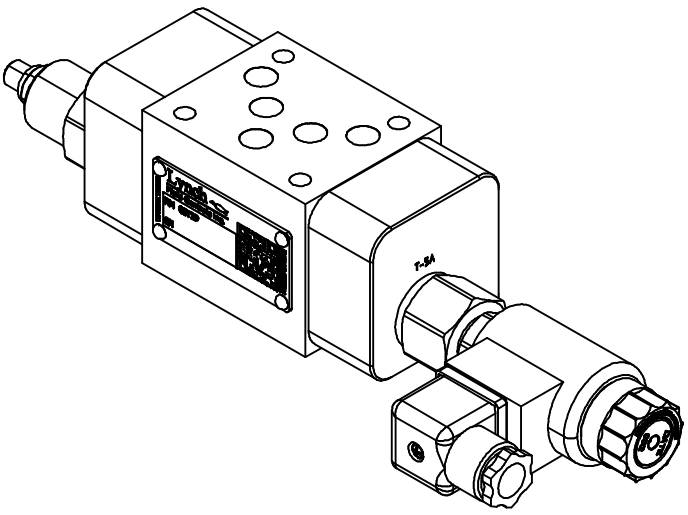

L - Standard Screw

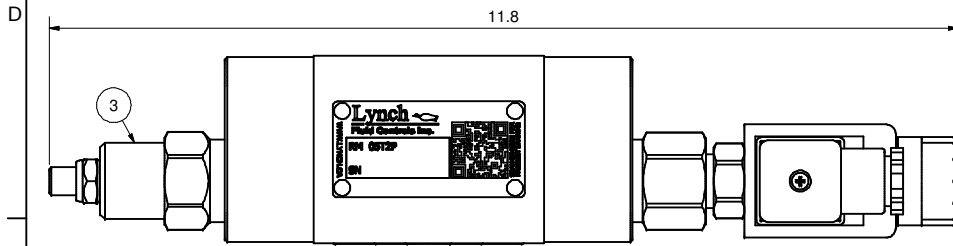

K - Hand-Knob

Non-Standard Option: Order Standard L control w/ 991 211 Kit

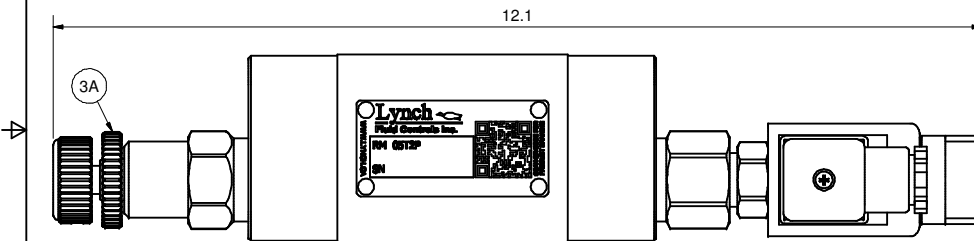

H - Calibrated Hand-Knob

Non-Standard Option

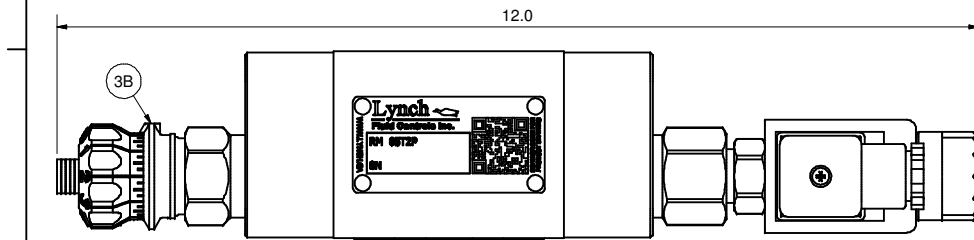

DWG NO	RM_05T2P-P^A@\$\$#D	REV	-
MODEL CODE	RM_05T2P-P^A@\$\$#D		
PROPRIETARY NOTICE THIS DRAWING DESCRIBES A PROPRIETARY PRODUCT OF LYNCH FLUID CONTROLS INC. WHICH MAY NOT BE REPRODUCED IN WHOLE OR IN PART NOR GIVEN TO A THIRD PARTY WITHOUT WRITTEN PERMISSION FROM LYNCH FLUID CONTROLS INC.		TITLE Technical Data & Non-Standard Options	
DATA UNIT: INCH	3RD ANGLE PROJECTION		

ITEM QTY		DESCRIPTION
3	1	[Flow Control] Fully adjustable pressure compensated flow control valve with reverse flow check
3A	1	[Flow Control] Fully adjustable pressure compensated flow control valve with reverse flow check [Hand-Knob]
3B	1	[Flow Control] Fully adjustable pressure compensated flow control valve with reverse flow check [Calibrated Hand-Knob]

Flow Control

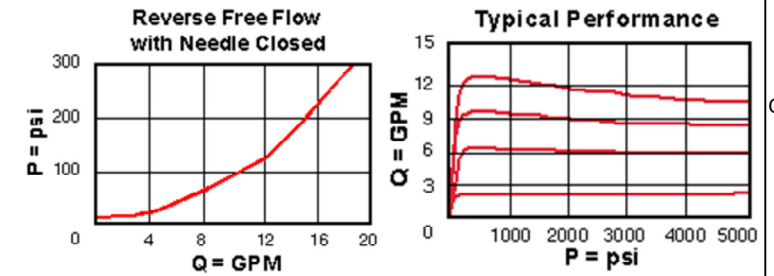

Main Stage

